

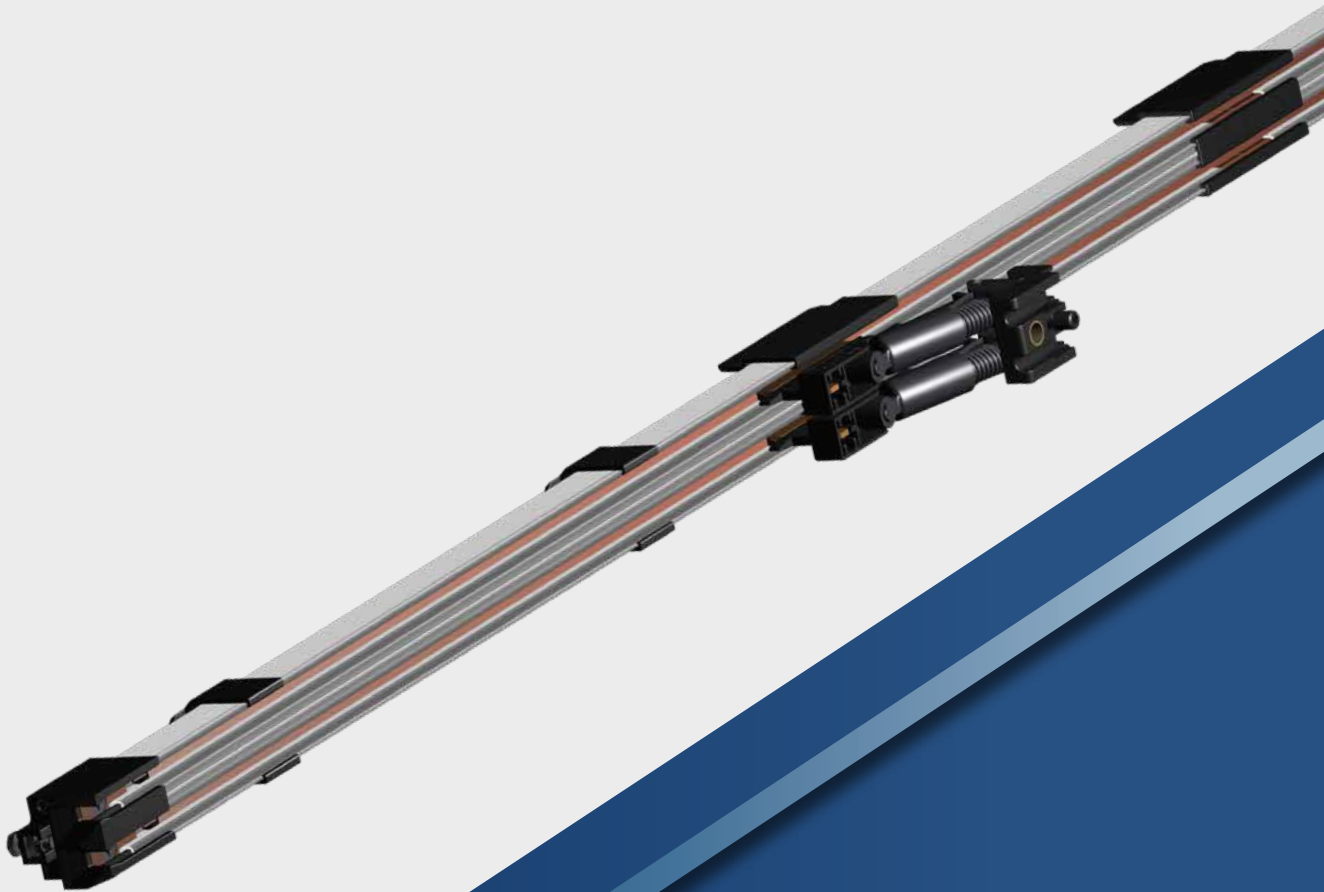

**COMPACT CONDUCTOR SYSTEM
VKL2**



GENERAL

The two-pole compact conductor system VKL2 was developed specifically for various intralogistics applications. With its compact size and durability, the VKL2 possesses the ideal properties for small parts warehouse shuttle applications or for other transfer carriages. Additionally, installing VKL2 is simple due to minimal parts and an easy clip-fastening system.

SAFETY

The compact conductor system, VKL2, has been designed according to VDE 0100. It complies with current conductor system safety requirements and is protected against accidental contact according to VDE 0470, part 1 (protection class IP 2X).

The current collectors are protected against contact only if the carbon brushes are fully located in the conductor rails. For conductor rail systems located at arm's length, where under normal operation the current collectors leave the conductor rails, contact protection must be provided on site, e. g. by means of barriers or by switching off. This, however, only applies to voltages above 25 volts AC or 60 volts DC.

Fig. 1 shows that the VDE finger cannot touch live parts. The insulation rail covering the conductor rail offers good insulation for maximum safety. Any number of conductors can be installed side by side at minimum space requirement.

Standard rail sections are 4 m long, but shorter sections are available. The ground conductor is yellow, marked with a continuous green stripe at the insulating housing.

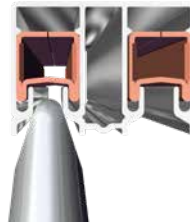

Fig 1: VDE finger

APPLICATION

For indoor systems with travel speeds of up to 300 m/min.

HANGERS

The maximum support distance between the hangers is 0.8 m.

JOINTS

Joints are used for the electrical and mechanical connection of the conductor rail sections. Every joint is protected against contact with a joint cap.

APPROVALS

UL approval in preparation.

EXPANSION

System lengths of up to 150 meters can be installed without additional expansion sections.

FEEDS

The feeds can be realized as an end feed via the transfer guides or on the line as a line feed.

TRANSFER GUIDES

Transfer guides are the contact-protected ends of the conductor rails at the end of the lines and mechanical line interruptions (switches, dropout sections, etc.). Transfer guides are available with or without feed capability.

CURRENT COLLECTORS

The current collectors are manufactured from impact-resistant plastic and stainless steel parts. The current is drawn via a carbon brush.

The length of the current collector connection cable may not exceed 3 m if the downstream overcurrent protection device is not designed to handle the capacity of the connection cable. Refer also to DIN VDE 0100, part 430 and DIN EN 60204-32. (Note: this is often the case if more than one collector is used in the system).

The cross section of the supplied connecting cables is designed for the stated nominal currents. The reduction factors according to DIN VDE 0298-4 must be observed for the various laying procedures.

According to DIN EN 60204-1 and DIN EN 60204-32, the continuity of the ground conductor system via sliding contacts must be ensured using suitable measures. As a simple and suitable measure, it is recommended to double the PE current collector.

SAFETY INFORMATION

To avoid pinching, ensure that the arrangement of the conductor system and current collectors / tow arms provides a minimum distance of 0.5 m between fixed and mobile plant parts.

STANDARD DESIGN FOR SHUTTLE APPLICATION

48V DC, 50 A

EXAMPLE OF 80 METER LINE

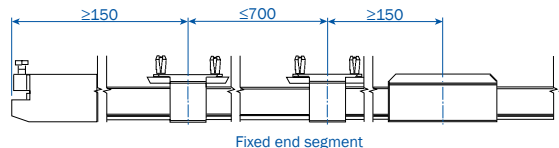
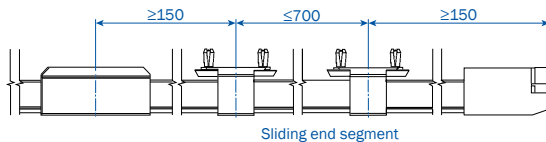
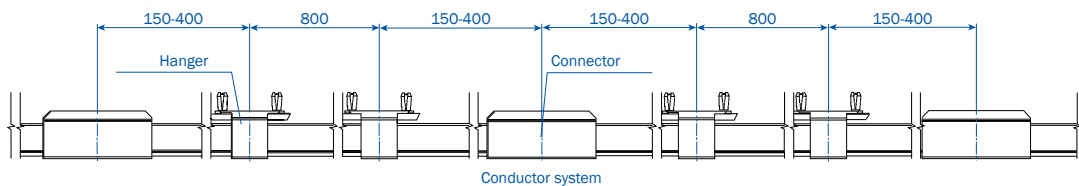
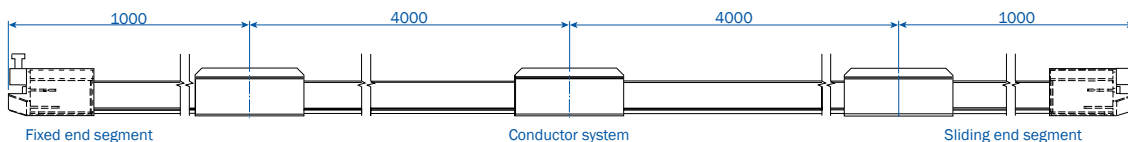
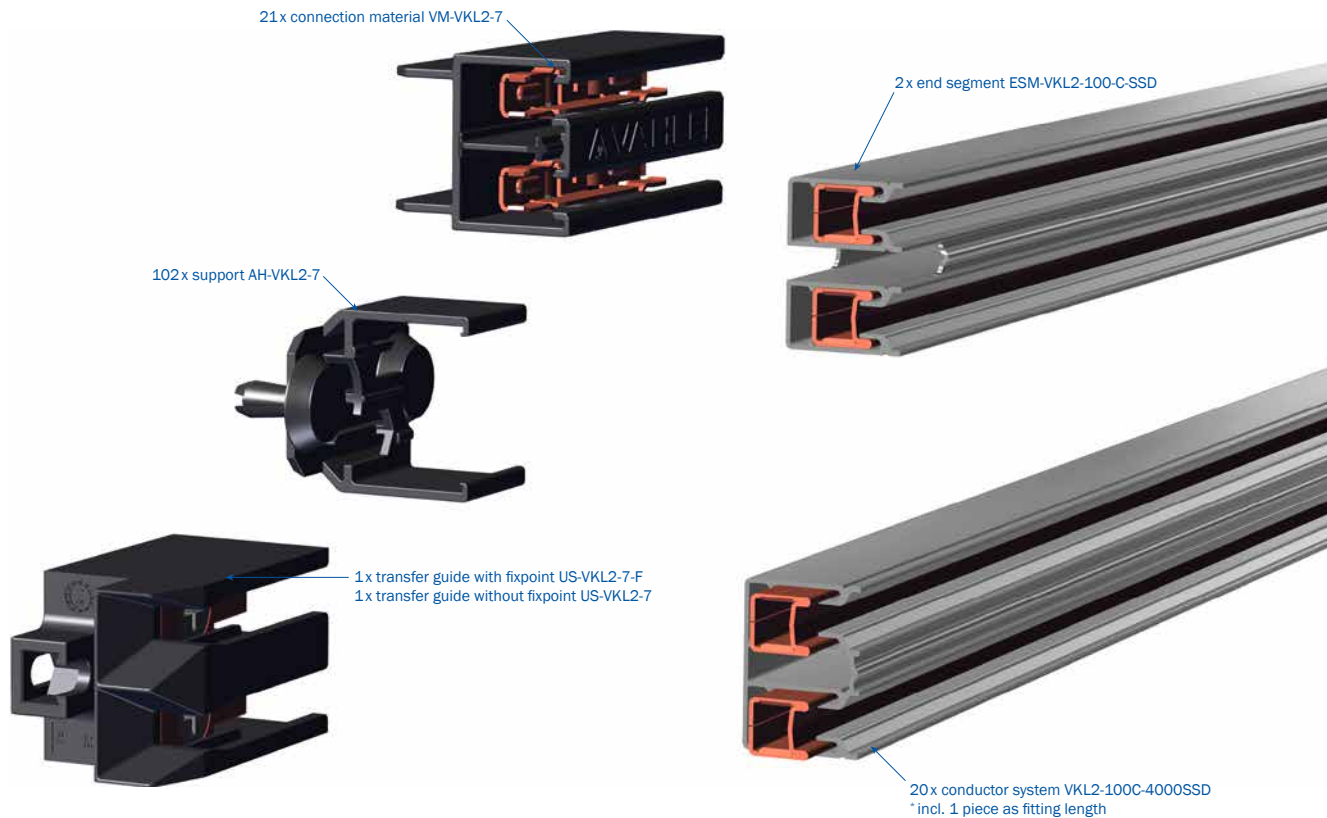

TECHNICAL SPECIFICATIONS

ISOLATING PROFILE

Electrical values: Dielectric strength according to DIN 53481	Specific resistance according to IEC 60093	Surface resistance according to IEC 60093	Comparative tracking index according to IEC 60112	Service temperature*	Flammability
>22.4 kV/mm	>8 x 10 ¹⁵ ohm x cm	2 x 10 ¹³ ohm x cm	CTI > 400	-30 °C to +55 °C	Flame-retardant, self-extinguishing, UL 94 V0

VKL2

LENGTH

4 m standard length,
shorter sections are available

SUPPORT SPACING

0.8 m for installation in straight runs

CONDUCTOR SPACING

15 mm

APPLICATION

Only for indoor systems

SECTION

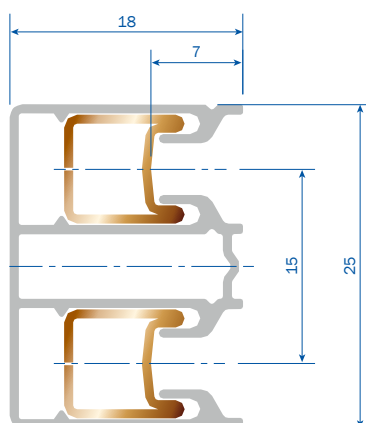

Type	Weight kg/m	Length m	Order No. phase	Order No. phase + PE
VKL2/100C-4000SSD	2.406	4	0281524	-
VKL2/100C-4000HSC	2.406	4	-	0281534
VKL2/40F-4000SSD	2.190	4	0281544	-
VKL2/40F-4000HSC	2.190	4	-	0281554

CONDUCTOR SYSTEM VALUES

Type	Conductor cross section** mm ²	Creepage distance of insulation mm	max. voltage V	max. continuous current A	Resistance ohm/1000 m	Impedance*** ohm/1000 m
VKL2/100C	25	32	24/48V AC/DC 500V AC	100	0.721	0.723
VKL2/40F****	25	32	24/48V AC/DC 500V AC	40	3.844	3.846

* For applications permanently below 0 °C (cold storage), please inquire separately.

** C = conductor material copper; F = conductor material galvanized steel

*** At phase spacing of 15 mm and frequency of 50 Hz.

**** VKL2 / 40F max. feed length 100 meters

ACCESSORIES VKL2

CONNECTING MATERIAL

100 Ampere

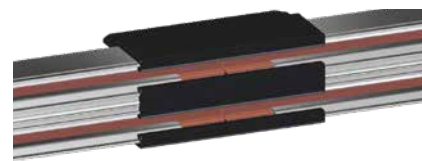

Type	Description	Weight kg	Order No.
VM-VKL2-7	Joint connector, plug-in	0.024	0281559

END SEGMENT**

Application: for line start and end with transfer guide



Type	Weight kg/m	Length m	Order No. phase	Order No. phase + PE
ESM-VKL2-100C-SSD	0.324	1	0281510	-
ESM-VKL2-100C-HSC-R*		1	-	0281515
ESM-VKL2-100C-HSC-L*		1	-	0281518
ESM-VKL2-40F-SSD	0.297	1	0281516	-
ESM-VKL2-40F-HSC-R*		1	-	0281517
ESM-VKL2-40F-HSC-L*		1	-	0281519

TRANSFER GUIDE**

with or without feed

(also used as end caps and as a fixpoint in connection with the provided carrier profile)

max. vertical and lateral offset ± 3 mm to each other,

please contact us for greater tolerances,

for use as infeed max 50 ampere



Type	Description	Weight kg	Order No. Height 27
US-VKL2-7-F	Transfer guide with fixpoint	0.055	0281556
US-VKL2-7	Transfer guide without fixpoint	0.052	0281555

* Lines with PE marking require 1x end segment...-HSC-R and 1x end segment...-HSC-L

** Pre-assembled unit with transfer guide or transfer guide with connecting cable on request

HANGER

For clip or screw fastening, expanding rivet is included in scope of delivery



Type	Description	Weight kg	Order No.
AH-VKL2-7	Support	0.004	0281520

Customer-specific supports on request

LINE FEED*

max. current 50A



Type	Weight kg/m	Straight section length	Order No. phase	Order No. phase + PE
ES-VKL2/100C-SSD	0.324	1	0281502	-
ES-VKL2/100C-HSC		1	-	0281503
ES-VKL2/40F-SSD	0.297	1	0281504	-
ES-VKL2/40F-HSC		1	-	0281505

*100 ampere on request

** Pre-assembled straight section with connection on request

EXPANSION JOINT

max. current 50A



Type	Weight kg/m	Straight section length	Order No. phase	Order No. phase + PE
DT-DVKL2/100C-SSD	0.324	1	0281506	-
DT-DVKL2/100C-HSC		1	-	0281507
DT-DVKL2/40F-SSD	0.297	1	0281508	-
DT-DVKL2/40F-HSC		1	-	0281509

LOCATING CLAMP*

Permissible only for voltages up to 48 volt

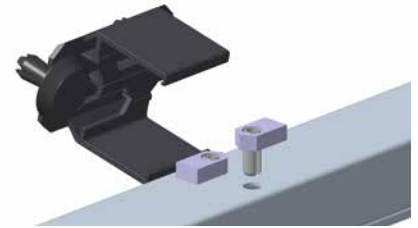

Type	Description	Weight kg	Order No.
FK-AH-VKL2	Locating clamp VKL2	0.020	0281527

DRILL TEMPLATE

For fixpoint terminal

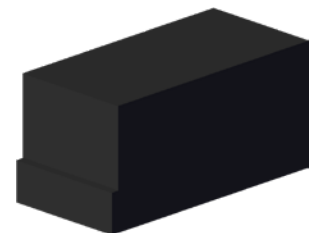

Type	Description	Weight kg	Order No.
MZ-BS-AH-VKL2	Drilling template for fixpoint	0.050	0281525

ASSEMBLY SAFETY DEVICE

Type	Description	Weight kg	Order No.
MZ-MK-VKL2	Assembly safety device	0.050	0281526

* Can be applied in special cases if the transfer guide cannot be used and a fixpoint is needed for technical reasons.

CURRENT COLLECTORS VKL2

CURRENT COLLECTOR SET D-EAS

Suitable for funnel

Phase spacing: 15 mm

Max. current: 30 A

Lift ± 12 mm, Swivel ± 20 mm

Contact pressure: approx. 4 N per carbon brush

HS version with PE current collector

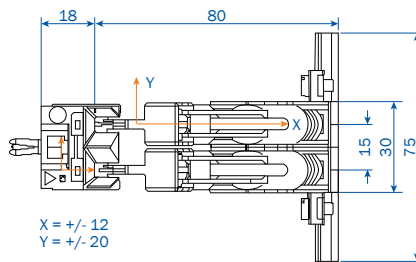

Type	Number of poles	Weight kg	Order No.
SA-DEAS-2/30-2-SS-2.5-02/2-2-PA	2	0.302	2823983/00-0
SA-DEAS-2/30-2-HS-2.5-0/2-2-PA	2 (PE)	0.302	2823998/00-0

CURRENT COLLECTOR SET EASL

Phase spacing: 15 mm

Max. current: 20 A

Lift ± 15 mm, Swivel ± 20 mm

Contact pressure: approx. 4 N per carbon brush

HS version with PE current collector

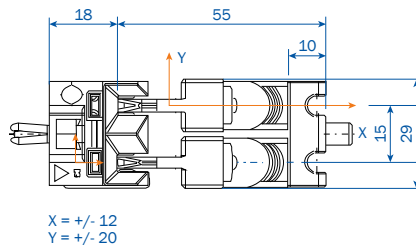

Type	Number of poles	Weight kg	Order No.
SA-EASL-20-2-SS-0-2-PA-V.E	2	0.098	2823982/00-0
SA-EASL-20-2-HS-0-2-2-PA-V.E.	2 (PE)	0.098	2823997/00-0

WEAR PARTS FOR CURRENT COLLECTOR

COLLECTOR BRUSHES FOR CURRENT COLLECTOR

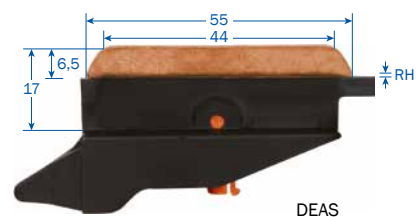
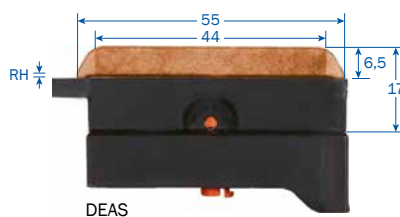
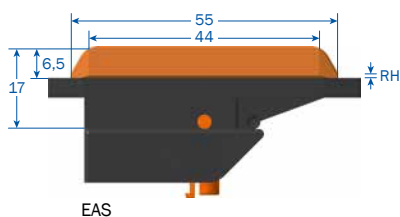

Type	Description	RH/mm	Weight kg	Order No.
SK-EK-DEAS-2/30-PH-32-6.3-H	Rear collector brush	0.5	0.016	2808580
SK-EK-DEAS-2/30-PH-32-6.3-V	Front collector brush	0.5	0.016	2808575
SK-EK-DEAS-2/30-PE-36-6.3-H	Rear collector brush	0.5	0.016	2808581
SK-EK-DEAS-2/30-PE-36-6.3-V	Front collector brush	0.5	0.016	2808576
SK-EK-EAS-20-PH-36-6.3-PA	Collector brush	0.5	0.014	2820750/00-PA
SK-EK-EAS-20-PE-36-6.3-HG-PA	Collector brush	0.5	0.014	2820751/00-PA

CONNECTING CABLE



CONNECTING CABLE, DOUBLE INSULATED, HIGHLY FLEXIBLE

For current collector, cable length: 1 m

Type	Cross section mm ²	A Ø mm	Weight kg	Order No. Phase black	Order No. PE green/yellow
AL-WFLA2.5PH1-6.3	2.5	4.5	0.038	2 809 179	-
AL-WFLA2.5PE1-6.3			0.034	-	2809183
AL-FLA2.5PH1-6.3	2.5	4.5	0.078	2 809 171	-
AL-FLA2.5PE1-6.3			0.034	-	2809175
AL-FLA4PH2-6.3	4.0	5.3	0.064	2 823 085	-
AL-FLA4PE1-6.3			0.058	-	2823086

CONNECTING CABLE, DOUBLE INSULATED, FLEXIBLE

For line feed with cable lug M6, cable length: 1 m



Type	Cross section mm ²	A Ø mm	Weight kg	Order No. Phase black	Order No. PE green/yellow
AL-RKLA2.5PH1-M6	2.5	4.5	0.038	2 808 979	-
AL-RKLA2.5PE1-M6			0.036	-	2808978
AL-RKLA4PH1-M6-HL	4.0	5.3	0.058	2 808 751	-
AL-RKLA4PE1-M6			0.052	-	2808752
AL-RKLA6PH1-M6	6.0	6.5	0.084	2 808 745	-
AL-RKLA6PE1-M6-HL			0.086	-	2808759

CONNECTING CABLE, DOUBLE INSULATED, FLEXIBLE

For transfer guide with cable lug M5, cable length: 1 m



Type	Cross section mm ²	A Ø mm	Weight kg	Order No. Phase black	Order No. PE green/yellow
AL-RKLA2.5PH1-M5	2.5	4.5	0.038	2808971	-
AL-RKLA2.5PE1-M5			0.036	-	2808958
AL-RKLA4PH1-M5-HL	4.0	5.3	0.059	2821809	-
AL-RKLA4PE1-M5-HL			-	-	2821810
AL-RKLA6PH1-M5-HL	6.0	6.5	0.110	2808965	-
AL-RKLA6PE1-M5-HL			-	-	2808967

MOUNTING ACCESSORIES FOR VKL2

TABLE SAW

For cutting insulating profile and conductor rails with length stop. Connection: 230 Volt, 50Hz.



Type	Weight kg	Order No.
Table saw KS 10	6.500	165276
Spare Blade SB	0.070	165263

HEXAGON SOCKET SW 4



Type	Weight kg	Order No.
Hexagon screwdriver 4 mm	0.036	2812962

MOUNTING HANDLE FOR PLUG-IN JOINT CONNECTOR



Type	Weight kg	Order No.
MZ-MGF100	0.010	2809348

DEBURRING TOOL FLAT BLUNT FILE FSF

For deburring the outside of the conductor rail in case of shorter sections.



Type	Weight kg	Order No.
Flat blunt file FSF 150x16x4	0.085	2812964

SCREW DRIVER PH1



Type	Weight kg	Order No.
Phillips screwdriver PH 1	0.014	2812963

QUESTIONNAIRE

Company: _____ Date: _____

Tel: _____ Fax: _____

E-mail: _____ Internet: _____

1. Number of wiper line systems: _____
2. Type of crane or device to be fed: _____
3. Operating voltage: _____ volt Phases: _____ frequency: _____ Hz
 Three-phase voltage AC voltage DC voltage
4. Line length: _____
5. Number of phase rails: _____ N-rails: _____ Control rails: _____ Ground conductor: _____
6. Installation position of the wiper line:
 Hanging wiper line / current collector cable downwards
 Hanging wiper line / current collector cable lateral entry⁽¹⁾
 Hanging distance _____ m (max. 2 m) Other: _____
7. Number of cranes or devices in a wiper line system: _____
8. Indoor system Outdoor system
9. Special operating conditions (moisture, dust, chemical influences, etc) _____
10. Ambient temperature: _____ °C min. _____ °C max.
11. Position and number of feeds⁽¹⁾: _____
12. Position and number of disconnecting points (e.g. for repair zones)⁽¹⁾: _____
13. Where is the wiper line to be positioned?⁽¹⁾: _____
14. Screw consoles to be supplied: yes no Distance middle of carrier – middle of wiper line _____
 Flange width of carrier: _____
15. Travel speed for longitudinal travel: _____ in bends: _____ at transfers: _____
16. Current consumption of the individual electricity consumers: _____
 (Please use the table below.)
17. Max. voltage drop from conductor rail feed to the current collectors and considering the start-up currents:
 3% or _____ % in relation to nominal current.

Motor data	Crane/device 1					Crane/device 2								
	Power kW	Nominal current			Start-up current		Drive type ⁽²⁾	Power kW	Nominal current			Start-up current		Drive type ⁽²⁾
		A	cos φ _N	% duty	A	cos φ _A			A	cos φ _N	% duty	A	cos φ _A	
Lifting device														
Auxiliary lifting device														
Carriage														
Trolley traveling winch														

Mark motors that can be switched on at the same time with an *.

Mark motors that can start up at the same time with Δ.

Further information: _____

Signature: _____

(1) Outline drawing required for offer preparation

(2) Enter drive type: K for squirrel-cage rotor, S for slip ring rotor, F for frequency-controlled motor

We reserve the right to make changes due to further technical development.

Please copy questionnaire and send by fax.



Paul Vahle GmbH & Co. KG

Westicker Str. 52
59174 Kamen
Germany

Tel.: +49 2307 704-0
Fax: +49 2307 704-444
info@vahle.de

www.vahle.com